

HEAT PRESS

INSTRUCTION MANUAL

SEMI AUTO OPEN

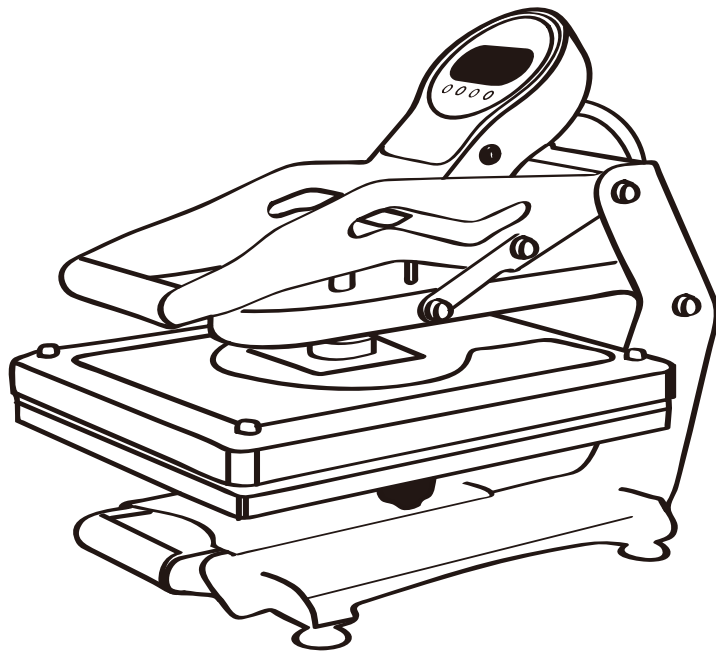

INTRODUCTION

The ultimate semi-auto heat press, prevent over-application and scorching, and allowing you to focus on more than one job at once. Full extending drawer with Non-slip Patent Technology™ allow you for easy garment layout or threads. It can lock down easily with magnetic assist, causing less fatigue on wrists and shoulders. Also the multi-timer allows user to pre-set individual time settings for three steps application or for pre-heating, application and strengthen. Over 10 kinds optional interchangeable lower platens available for different application.

READ BEFORE OPERATING MACHINERY Read this manual carefully to ensure you use the press correctly. After reading and familiarizing yourself with the equipment, store the manual in a safe place for future references.

SAFETY PRECAUTIONS

The following precautions are provided to prevent harm or injury to yourself and others. Please make sure to thoroughly read, understand, and follow these precautions before using the product.

WARNING: Follow the warnings below. Otherwise, death or serious injuries may occur.

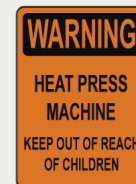

- Use this product only as described in this manual.
- Unplug the heat press from the electrical outlet and let it cool down COMPLETELY before cleaning, performing maintenance, or repair.
- DO NOT operate the product after the appliance malfunctions or is dropped or damaged in any way.
- DO NOT operate the press if the plates are dirty. Clean the plates with isopropyl alcohol and wipe them dry with a clean cloth. Ensure both plates are completely dry before use.
- DO NOT immerse the press, its power cord, and plugs in water or any other liquid.
- DO NOT operate the product with a damaged cord or plug.
- DO NOT handle a power plug or other components of the press with wet hands.
- DO NOT connect too many power plugs to the same power outlet.
- DO NOT disassemble the press or make any to the equipment.

UNPACKING

UNPACKING PRECAUTIONS

WARNING: Keep the packaging materials (cardboard, foam, plastic bags, etc.) out of the reach of children to prevent accidental choking, **suffocation, strangulation, and other injuries.** Preserve the shipping carton. DO NOT discard or disassemble the shipping box. It is designed to hold the weight of the product and should be used in case you need to return the equipment for repair or warranty maintenance in the future.

UNPACKING INSTRUCTIONS

1. Place the box on a large, sturdy, flat surface.
2. Open the box and remove the instruction manual and all parts that came with the press.
3. Remove the packaging material and carefully lift the press out of the box.
4. Remove any protective or promotional labels from the press and other parts if applicable.
5. Examine the heat press after unpacking for any damage. If found one, take a picture and contact us immediately.

ITEM CHECKLIST

Before starting, please make sure that the following items are included with your press machine. If anything is missing, contact us, please.

1. SEMI AUTO OPEN Heat Press
2. AC Power Cord;
3. Instruction Manual.

RECOMMENDED PARTS The following items are recommended to use with this machine:

1. Teflon Cover
2. Teflon Sheet
3. Silicone Mat
4. Teflon Pillow if there is a zipper or unflated things on your materials.
5. Please contact us if you don't have above things.

GETTING FAMILIAR

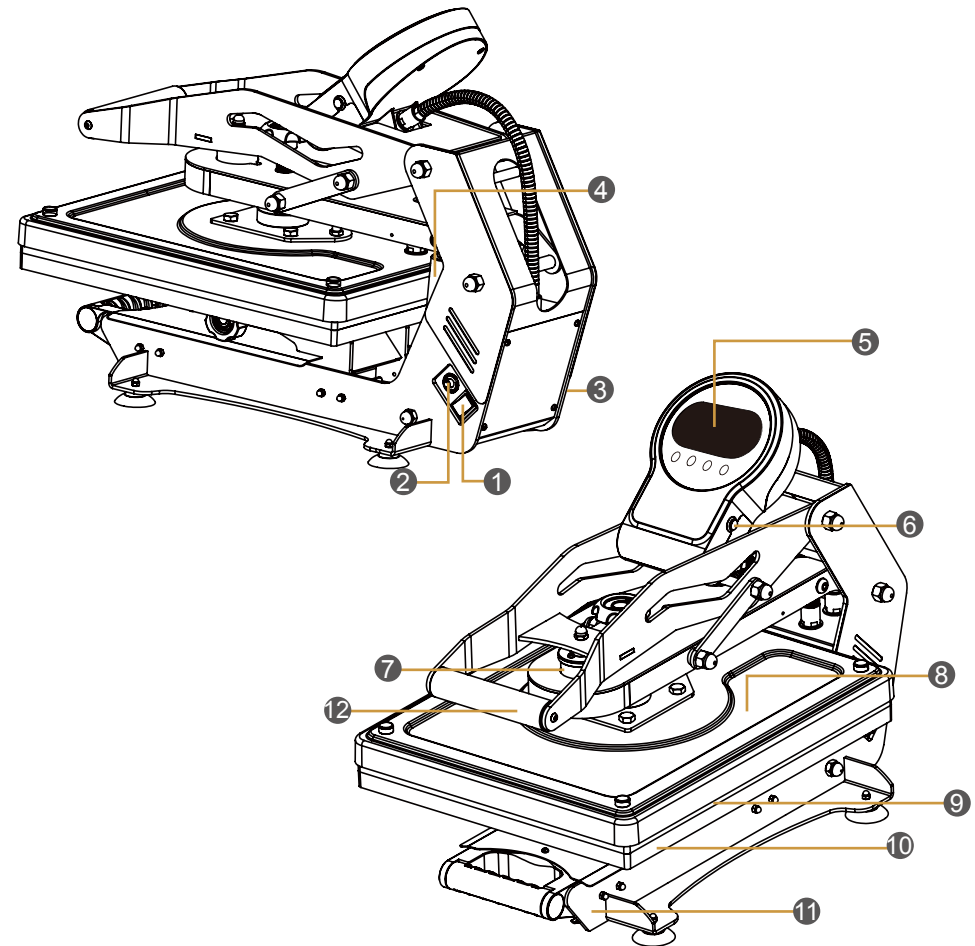

- | | | | |
|-------------------|------------------------|-------------------|--------------------|
| 1 Power Switch | 4 Air Shock | 7 Magnetic Device | 10 Bottom Plate |
| 2 Thermal Breaker | 5 Controller Display | 8 Heating Plate | 11 Pull-Out Drawer |
| 3 Power Plug | 6 Quick Release Button | 9 Silicone Mat | 12 Handle Grip |

OPERATING INSTRUCTIONS

PREPARING PRESS 1. Prepare materials you wish to press.

OPERATING INSTRUCTIONS (continued)

PREPARING PRESS (continued) 2. Make sure the press stands on a flat sturdy countertop.
3. Insert the AC cord that came with the product into the press AC power cord socket ❸ and then plug its other end into an electrical outlet (110V/220V).

STARTING PRESS Flip the ON/OFF switch ❶ to turn the press on. The control panel ❺ lights up.

SETTING CONTROL PANEL 1. Press Set ❶ button on the control panel (Fig. 1) to go to the temperature setting mode for the heat platen.
2. Press Up ❷ or Down ❸ buttons to select the desired temperature (Fig. 2). The selected temperature is flashing on the display.



Fig. 1

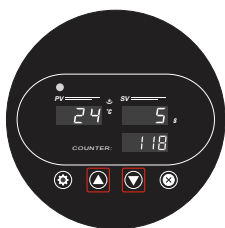

Fig. 2



Fig. 3

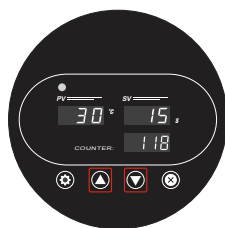

Fig. 4

OPERATING INSTRUCTIONS (continued)

SETTING CONTROL PANEL (continued) 3. Press Set ❶ button again (Fig. 3) to go into the timer setting mode.
4. Press Up ❷ or Down ❸ buttons to select the desired time in seconds (Fig. 4).
5. Press Set ❶ button to go to the temperature scale selection mode (Fig. 5).
Tip: Depending on your machine's default settings, you may either see "F" or "C" on the display indicating the currently selected temperature scale (°F or °C).

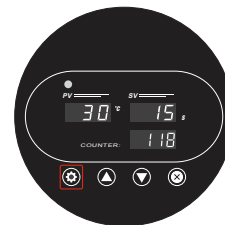

Fig. 5

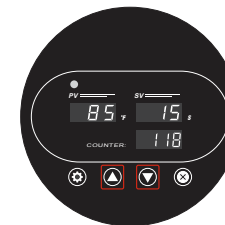

Fig. 6

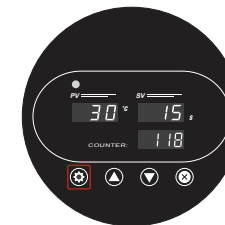

Fig. 7

6. Press Up ❷ or Down ❸ buttons to select either °F or °C (Fig. 6) OR skip this step if you are satisfied with the current selection.
7. Press Set ❶ button once more (Fig. 7) to record all control panel settings. The platens start heating, and the heating icons are now displayed on the screen (Fig. 8).

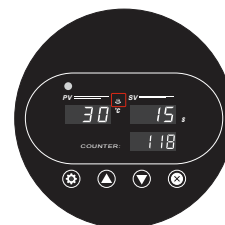

Fig. 8

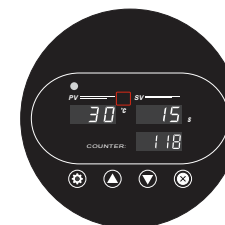

Fig. 9

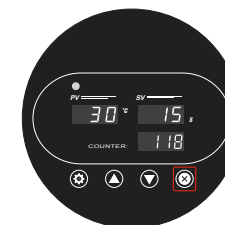

Fig. 10

PRESSING 1. Wait until the platens reach the desired temperature(s) and the heating icons are turned off (Fig. 9).
2. Place the prepared material in the center of the bottom platen ❿.
3. Push Down ❿ handle grip to lower the top platen ❸ and start pressing.

OPERATING INSTRUCTIONS (continued)

PRESSING
(continued)

- Short Press the (X) button on the control panel (Fig. 10). The control panel starts showing a countdown. Tip: Long press (X) to clear counter.
- Wait until the countdown ends and the press starts beeping. And the machine will open automatically.
- Remove the pressed material using heat resistant gloves or tools and exercising extreme caution.
- Tips: You can also stop the pressing before it open by press the quick release button 6

TURNING OFF
PRESS

- Turn off the machine by flipping ON/OFF switch 1 when done pressing.
- Unplug and then disconnect the AC power cord from the press.
- Wait until the platens cool down completely to clean and store the press.

CLEANING
PRESS PLATES

- Make sure the press plates are completely cooled down before cleaning.
- Apply a small amount of alcohol to a clean cloth and wipe down the plates until clean. Use rubbing alcohol that contains at least 80% by volume of isopropyl alcohol.
- Wipe plates with a dry clean cloth.
- Repeat these steps for cleaning all associated tools.

MULTI TIMER
ACTIVATION
SETTING

- Long press (⊕) set button on the control panel (Fig.11) about 8 seconds, and the machine will enter into the internal setting . Then Press (⊕) the set button twice until it shown like this. (Fig.12).
- Press the up (▲) and (▼) down buttons to select the timer you need, including 1,2 and 3, and the control panel will also show the light quantity as per the timer you set (Fig.13).
- After selected, then give a long press about 8 seconds to the (⊕) set button, it will record settings and back to the original panel to work(Fig.14).

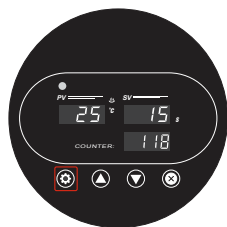

Fig. 11

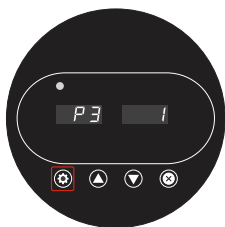

Fig. 12

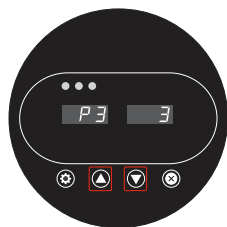

Fig. 13

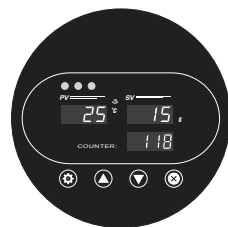

Fig. 14

Tips: If you want to adjust the timers just repeat the above settings.

TECHNICAL SPECIFICATIONS

Model	SEMI AUTO OPEN
Voltage	110V/220V
Heat Plate	40 x 50
Power	1800W-2200W
Controller	LCD Controller
Max. Temperature	232 °C/ 450 °F
Temp. Accuracy	±4 °F / 2 °C
Max. Pressing Force	360kg
Working Style	Lever Mechanism & Magnetic
Stand-by Feature	Max. 120 mins
Accept Thickness	≤1cm
Dimensions (L x W x H)	76.0 x 62.5 x 49.0cm
Packaging (L x W x H)	77.5 x 64.0 x 50.8cm
Product Weight	50kg
Shipping Weight	52kg
Certificate	CE,UKCA